

Лепные украшения из полиуретана

Есть такие вещи, без которых в доме не обойтись! Сантехника, бытовая техника, мебель. А есть то, что превращает помещение, в котором мы живем, в апартаменты. Если Вам приелась безликая непритязательность окружающей обстановки и Вы давно мечтаете о чем-нибудь гораздо более выразительном и стильном, то этот путеводитель для Вас.

Римская классика, классицизм, барокко, модерн - предстанут перед Вами в более чем 500 элементах лепного декора. Из современных коллекций лепнины, только производитель Gaudi Decor может предложить покупателю такое многообразие и богатство ассортимента. Gaudi Decor - самая крупная коллекция лепных украшений на мировом рынке.

Коллекция Gaudi Decor - это лепнина из вспененного полиуретана, современного материала, пришедшего на смену гипсу и алебастру. Вспененный полиуретан был изобретен в России в 30 годы XX века, а в 60 - этот синтетический материал получил широкое распространение в Европе.

Легкую, но при этом столь же пластичную, как гипсовая, полиуретановую массу заливают в специально выточенные металлические формы, в результате чего получают изделия малого веса с прекрасно очерченным рельефом рисунка.

Прочный, экологически чистый, легкий полиуретан делает лепной декор максимально приспособленным для украшения интерьера любой сложности. Лепнина не желтеет со временем, не осыпается, не растрескивается, не теряет четкости рельефа, не собирает пыль. Ее можно подвергать влажной уборке. В отличие от мягкого полистирола, который также используется в производстве лепных украшений, она при любых условиях сохраняет форму.

Современный дизайн избегает однообразия, пусть даже классического. Традиционно белые лепные украшения сегодня все чаще подвергают той или иной покраске. Благодаря специальной грунтовке, поверхность декора Gaudi Decor изначально подготовлена к ней. Для этой цели можно использовать любые водоэмульсионные, акриловые, масляные краски.

Монтаж декоративных лепных украшений Gaudi Decor достаточно прост, и может быть осуществлен домашним мастером.

Коллекция Gaudi Decor включает в себя весь спектр декоративной лепнины, необходимый для воплощения законченного и гармоничного замысла. Это богатейший набор карнизов для оформления стыков стен и потолка, молдинги для украшения стен и потолка, розетки, оформляющие пространство вокруг люстры, пилястры, колонны, пьедесталы, а также множество других декоративных элементов, чья уместность в интерьере проверена временем.

С помощью лепного декора Gaudi Decor можно воссоздать любую, историческую эпоху в отдельно взятом пространстве или сконструировать собственный новомодный стиль в духе современного эклектизма. Магическому очарованию классических форм найдется место в любой обстановке.

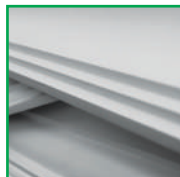

Карнизы с гладким профилем
4



Карнизы с орнаментом
10



Молдинги
19



Угловые элементы
27



Круговые бордюры
30



Потолочные розетки
32



Кессоны
38



Орнаменты
40



Консоли
42



Обрамление порталов
44



Пилястры
46



Колонны
50



Пьедесталы
56



Настенное панно
57



Обрамление дверных проемов
65



Ниши
69



Купола
72

Инструкция по монтажу лепного декора из полиуретана



1. Сделайте отметки карандашом на стене, чтобы определить местоположение карниза.



2. Используя ножовку, отрежьте карниз под углом 45 градусов.



3. Нанесите клей вдоль по краям обратной стороны карниза, а также на поверхность, которую будете клеить.



4. Соедините оба карниза вместе, чтобы их профили совпадали. Используйте специальный клей для стыковки изделий.



5. Перед тем как забить гвозди, убедитесь в ровности соединения.



6. С помощью ножика для замазки швов обработайте стыки карнизов.



7. Для шлифовки поверхности используйте наждачную бумагу.



8. Закройте стены и потолок тепп-лентой. Используя кисточку, покройте краской карниз.

Перед установкой элементов лепнины необходимо, чтобы изделия были адаптированы к помещению. Для этого следует их оставить на 24 часа в данном помещении.

Предварительно следует убедиться, что стены и потолок в местах монтажа лепнины сухие и чистые, для более надежной склейки их с полиуретаном.

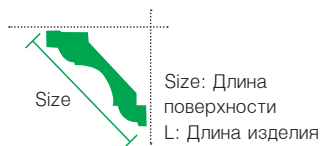

Карнизы - выступающие элементы внутренней и внешней отделки зданий, помещений, мебели. В архитектуре карниз отделяет плоскость крыши от вертикальной плоскости стены по выделенным горизонтальными линиями. Карниз из полиуретана - декоративный элемент, соединяющий шов между потолком и стенами.

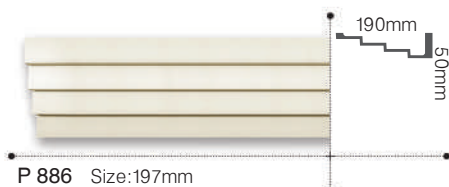
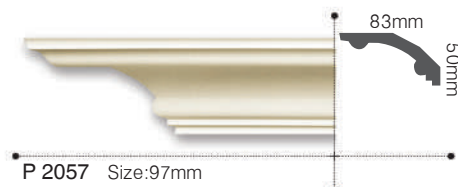
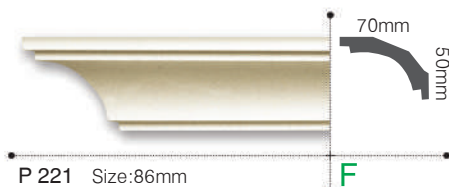
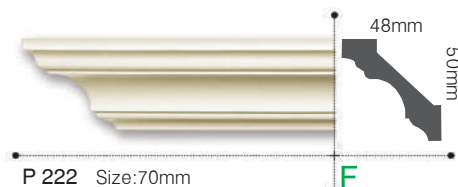
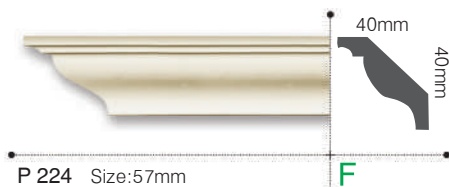
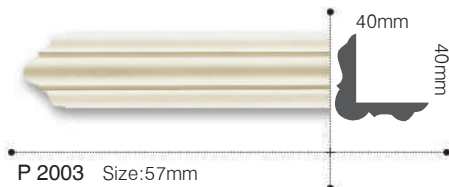
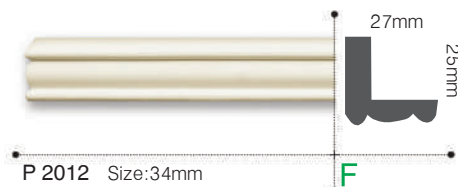

Карнизы с гладким профилем

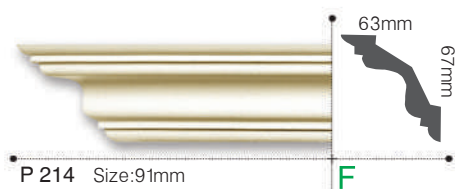
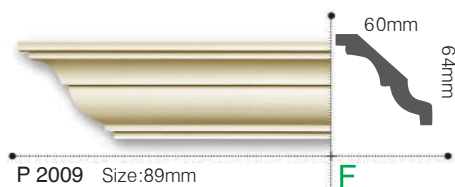
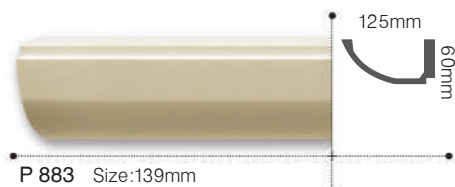
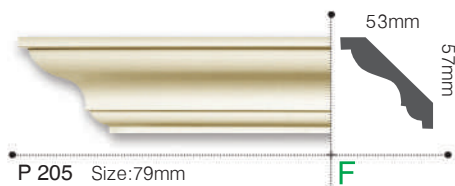
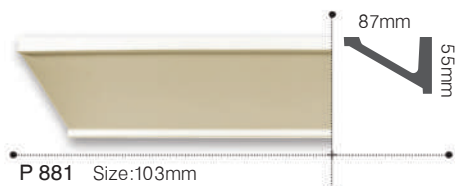

F - элемент имеет гибкий аналог

*длина элементов 2440mm

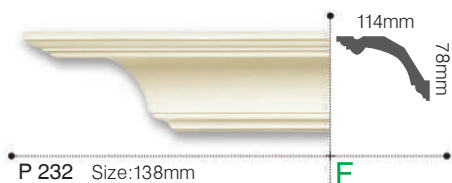
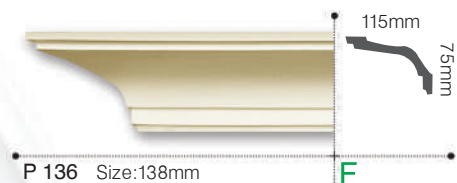
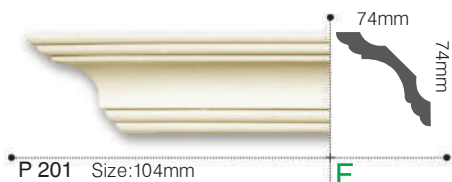
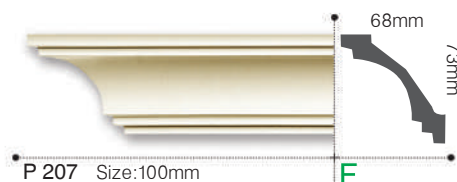
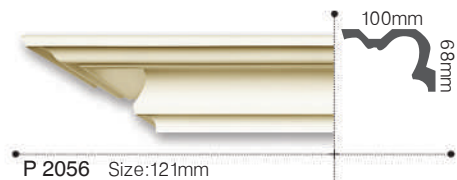

Карнизы с гладким профилем

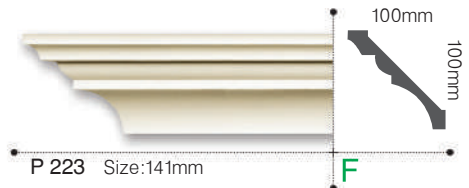
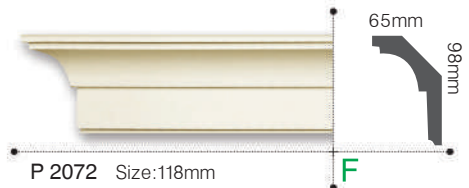
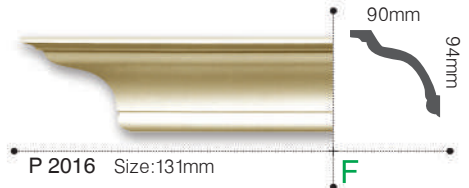
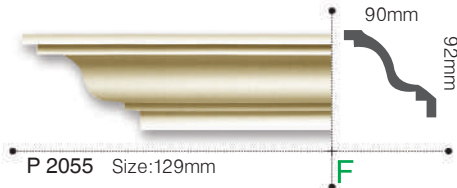
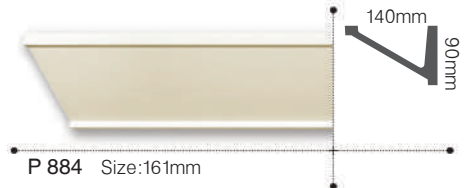
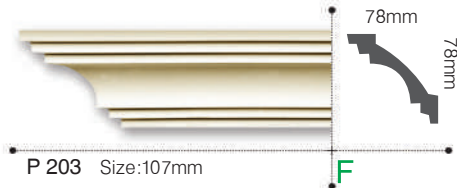
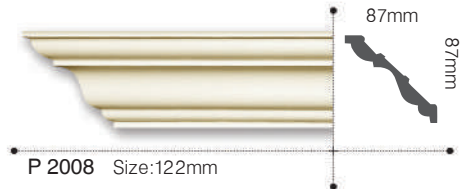
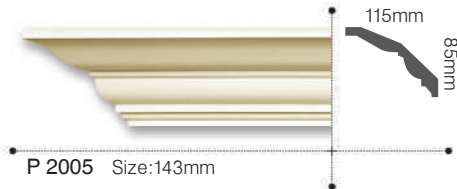
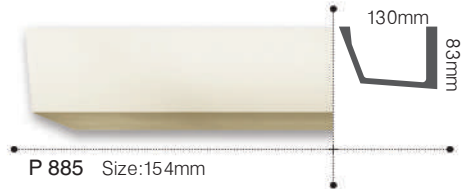
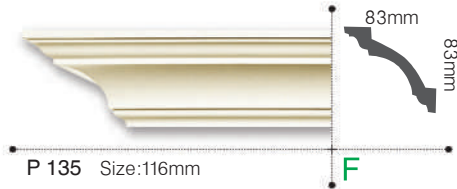

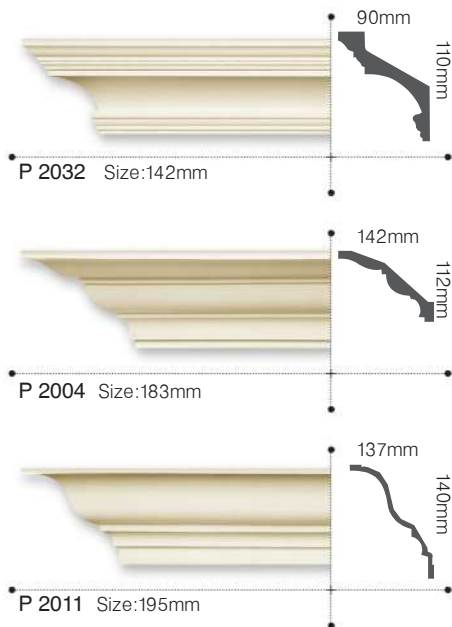
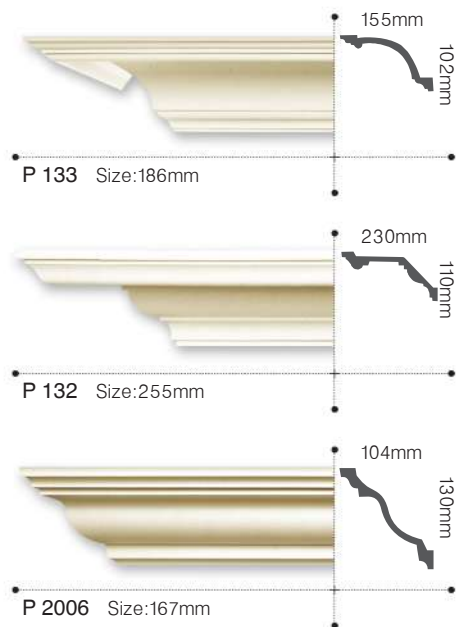

Карнизы с гладким профилем

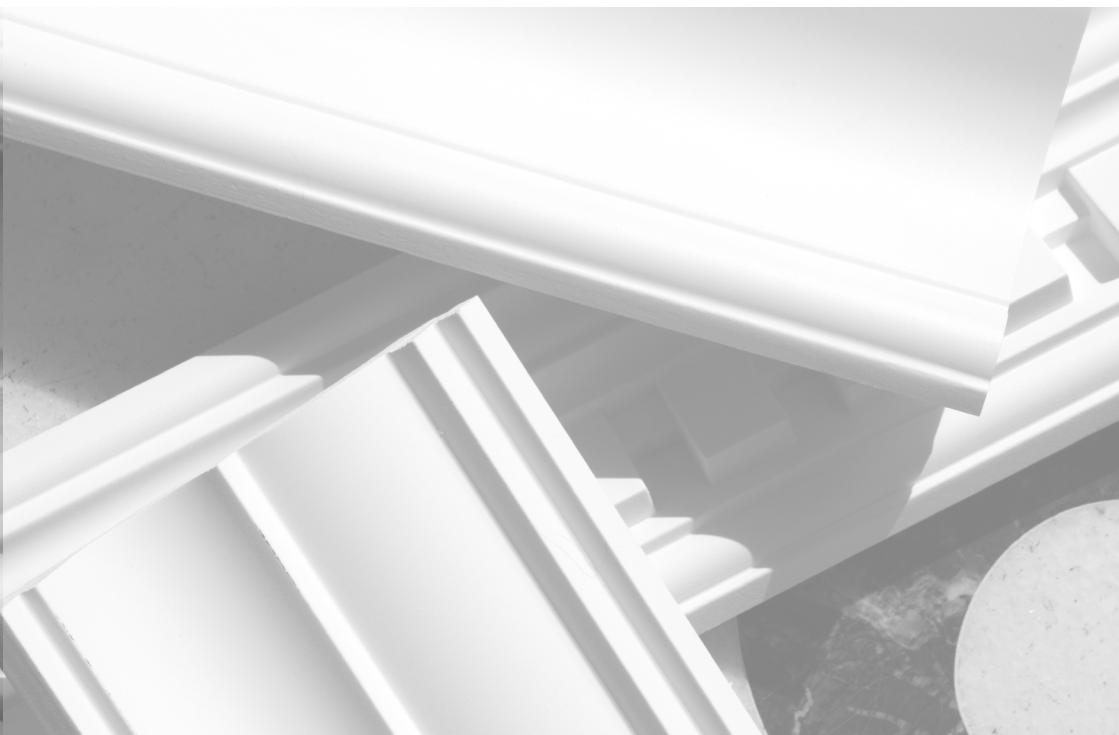
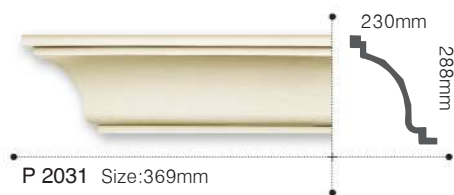

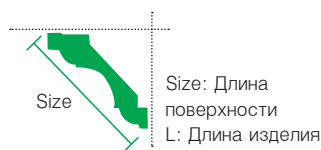

Карнизы не только оформляют периметр потолка, но и скрывают возможные неровности стыка потолка и стен. Каждый вид карниза или группа орнаментов позволяют создавать особое стилевое решение. Возможны комбинации карнизов гладких и с орнаментом. Их прочность гарантирует долгую службу, а возможность покраски поможет им удачно вписаться в интерьер.

В коллекции "Gaudi Decor" - обширный ассортимент карнизов с различными видами орнаментов.

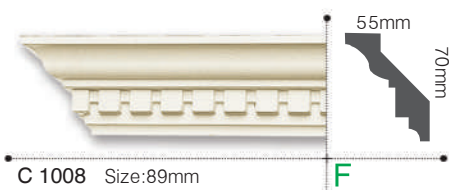
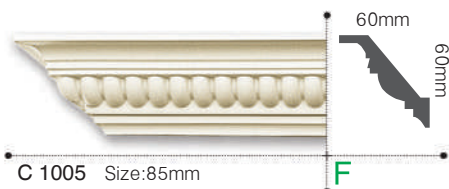

Карнизы с орнаментом

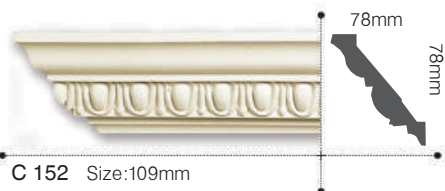
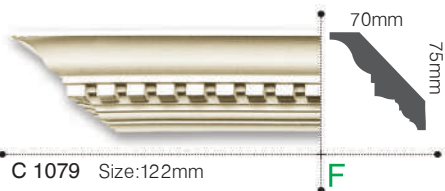
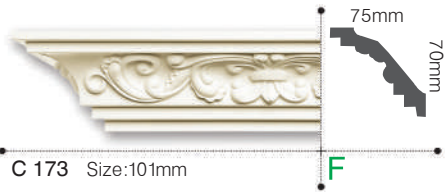
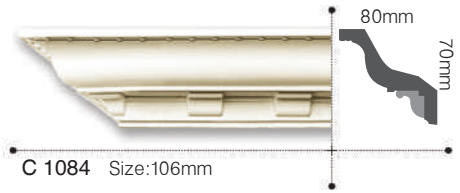

F - элемент имеет гибкий аналог

*длина элементов 2440mm

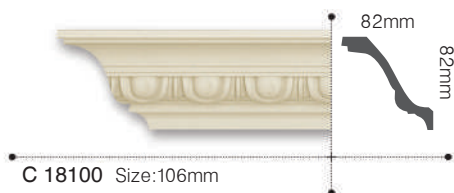
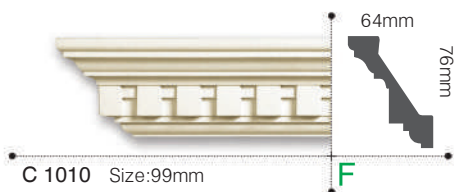

Карнизы с орнаментом

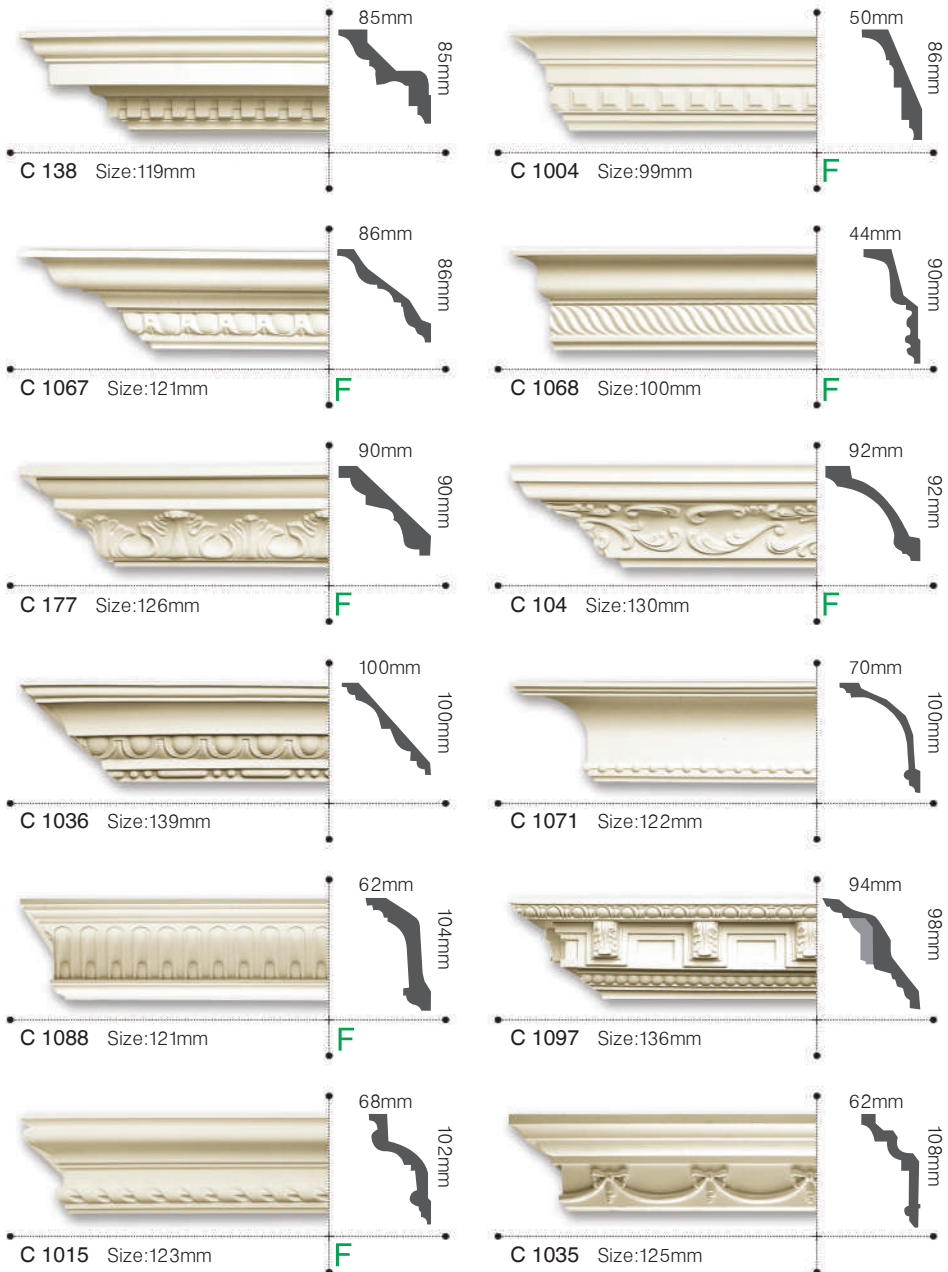

F - элемент имеет гибкий аналог

*длина элементов 2440mm



Карнизы с орнаментом

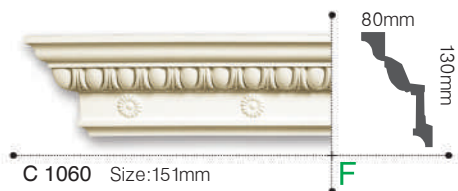



Карнизы с орнаментом



P 149 175×175mm



P 149 175×175mm



C 156 175×175mm



C 156 175×175mm



C 156 175×175mm



P 149 175×175mm

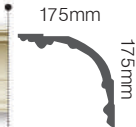

C 150 175×175mm

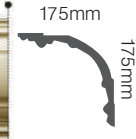

1210mm



C 156 175×175mm

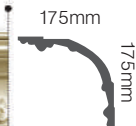

410mm

*длина элементов 2440mm



C 1093 118×123mm

C 1093 118×123mm

C 1091 118×123mm

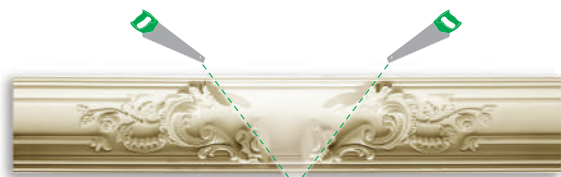

C 1091 118×123mm



C 1091 118×122mm



C 1093 118×123mm



C 1092 118×123mm



870mm



C 1091 118×123mm



305mm

SIZE: Длина
L: поверхности
Длина изделия



Молдинги

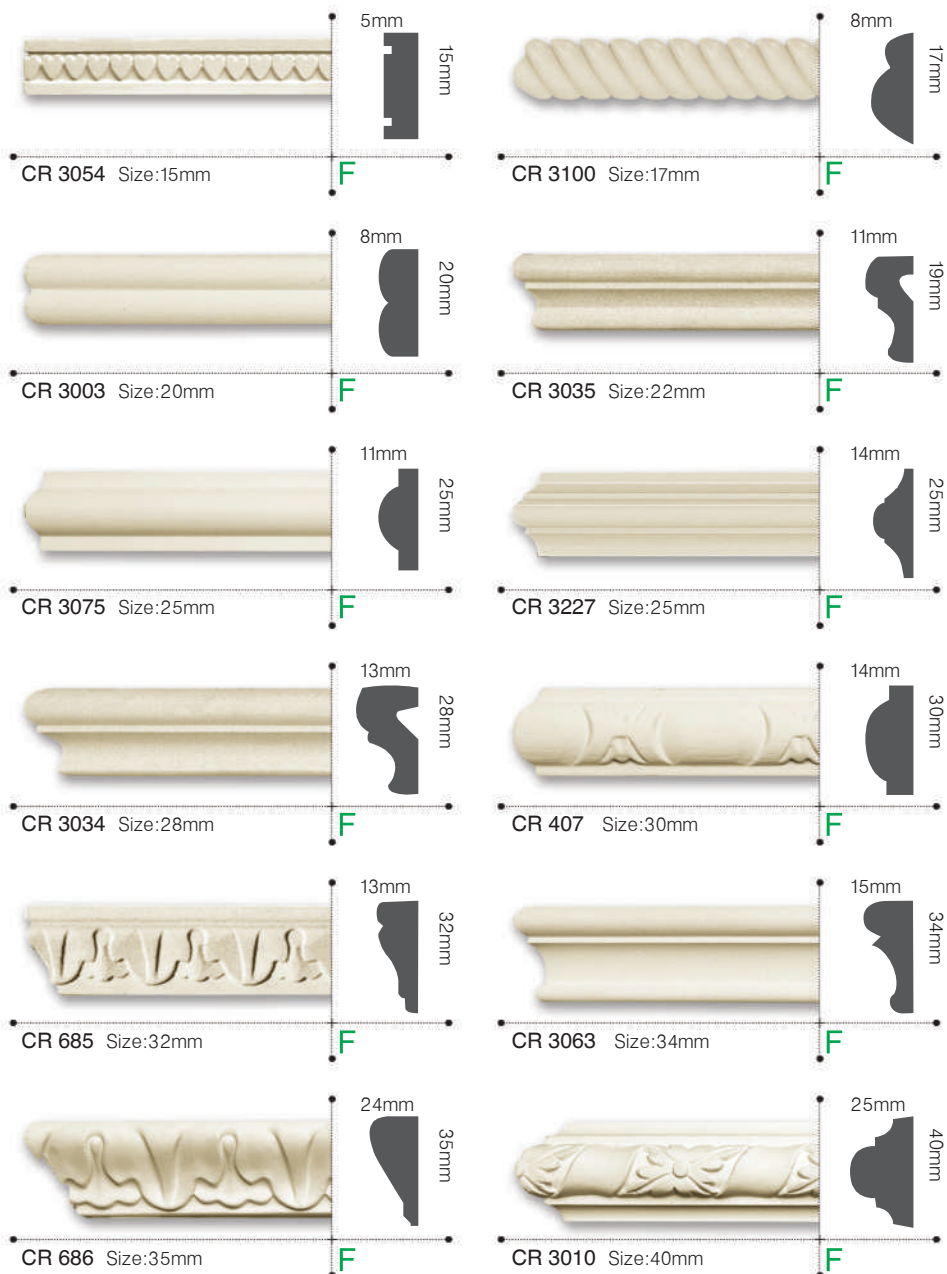

F - элемент имеет гибкий аналог

*длина элементов 2440mm

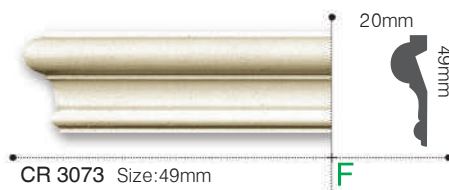
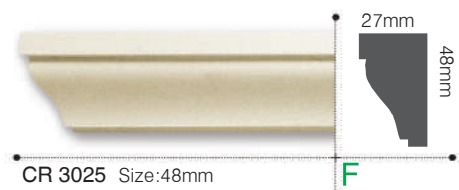
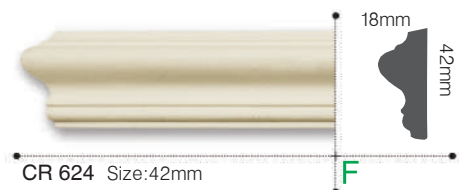
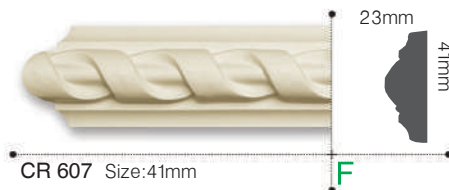
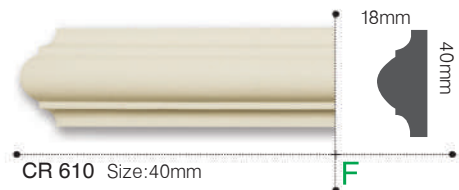

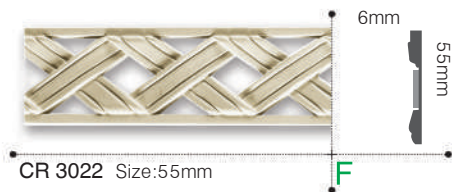
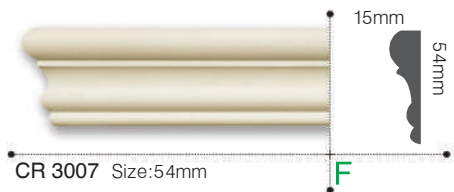

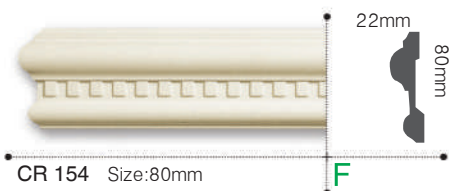
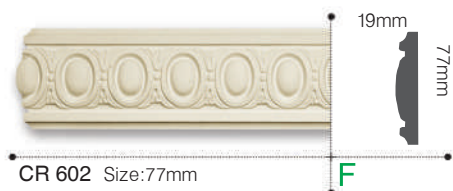
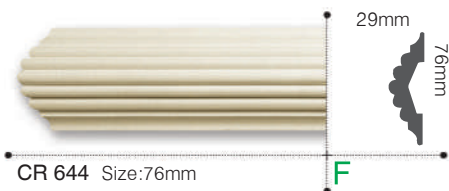
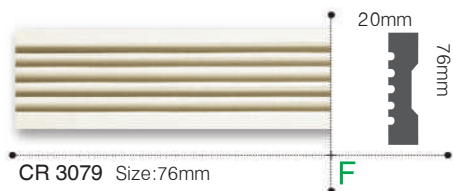
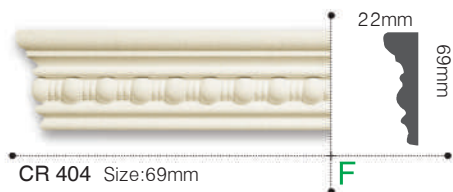
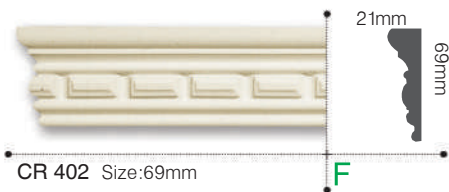

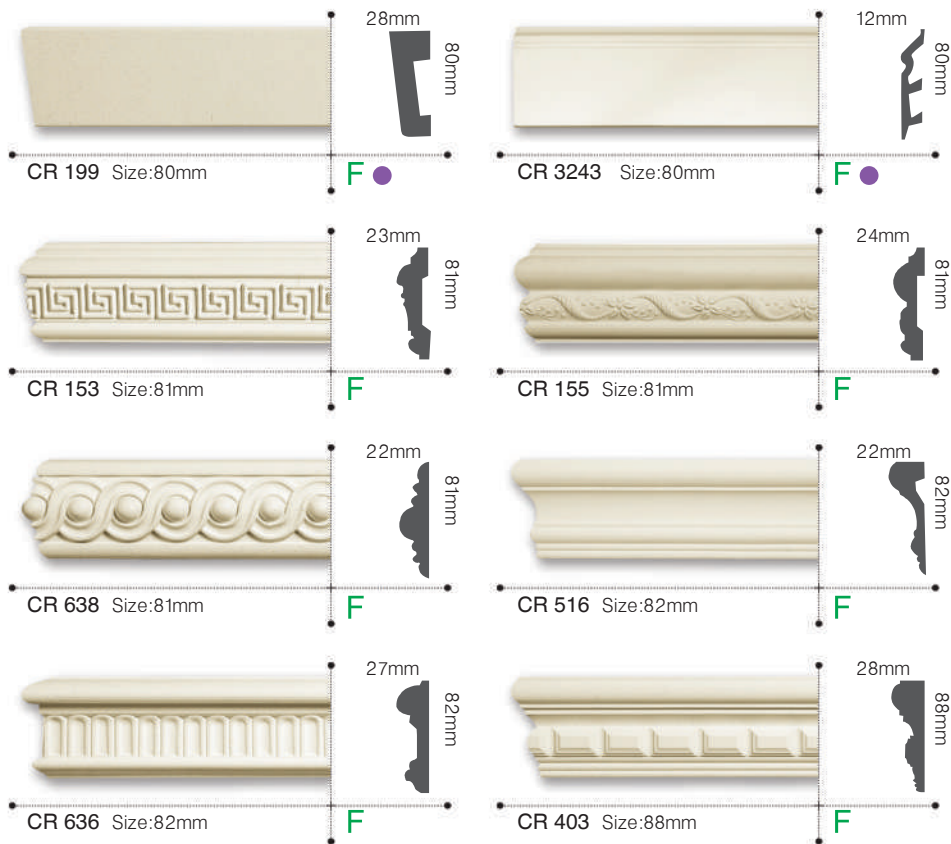

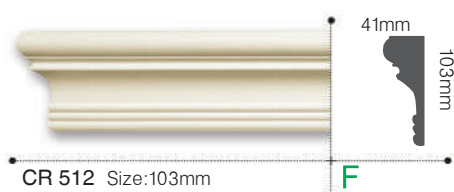
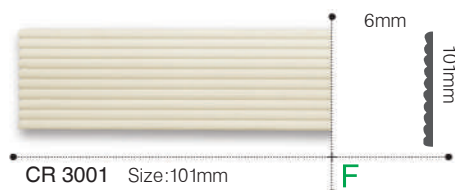
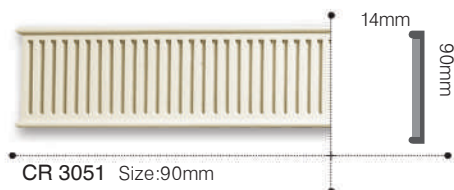

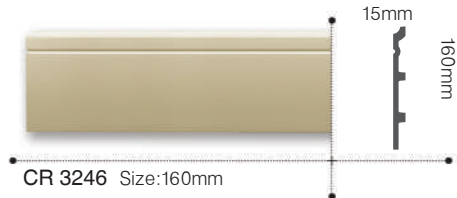
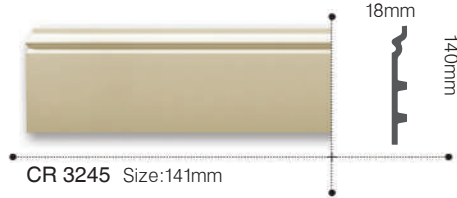
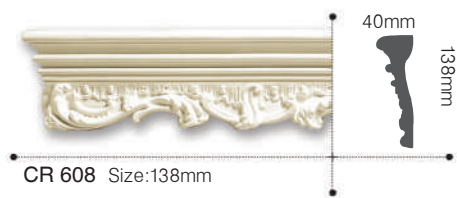
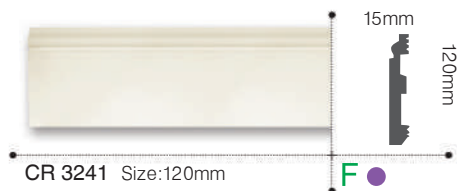

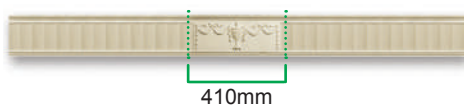
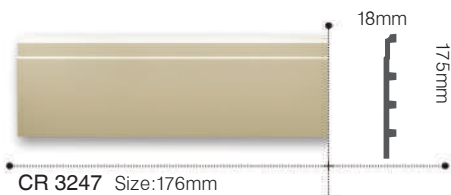

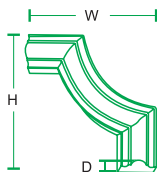

Угловые элементы и бордюры обычно используют для оформления плоскости потолка или стен определенным рельефом или узором. Оформленные таким образом стены или потолок приобретают изящные формы.

Лучшие образцы архитектуры элементов декора от древнегреческой классики до модерна используются для придания интерьерам насыщенной и завершенной композиции.

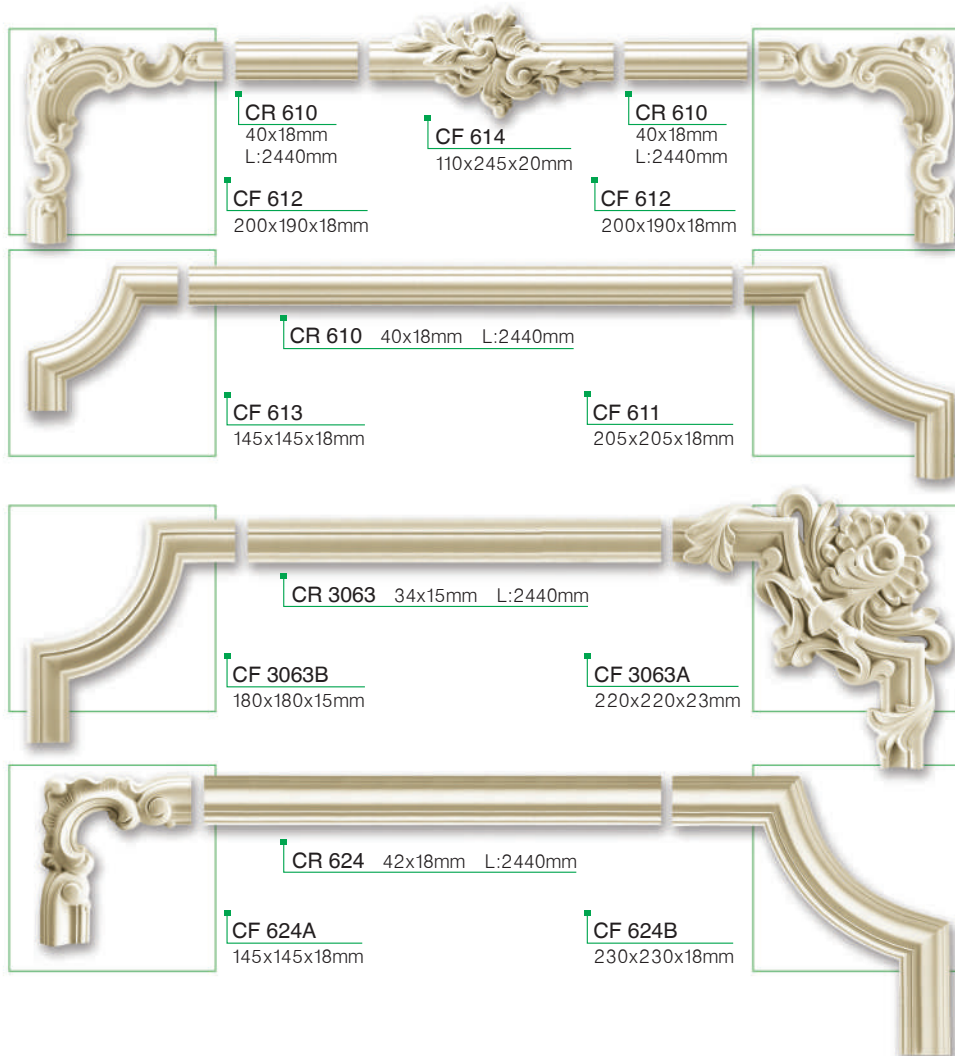

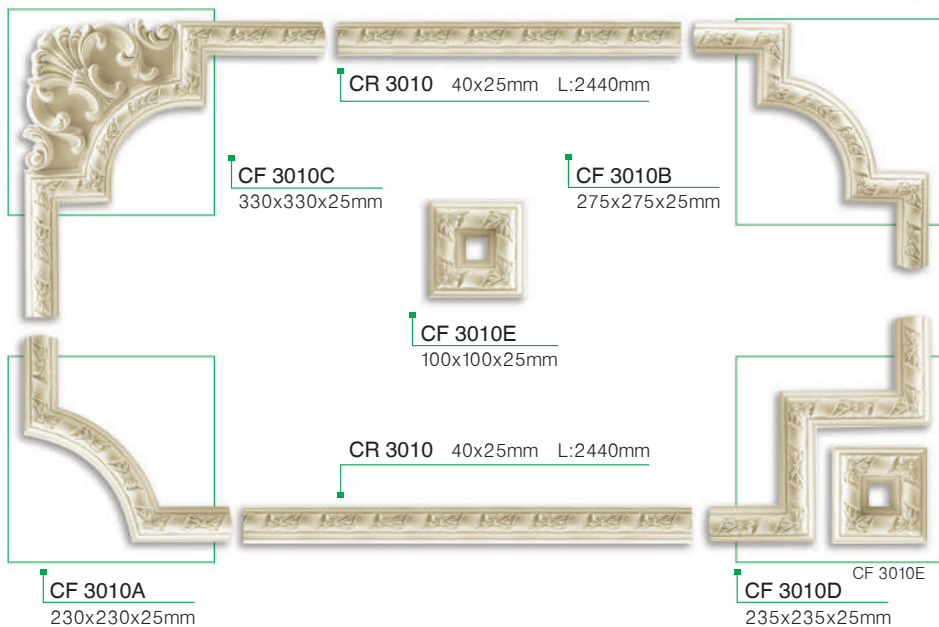
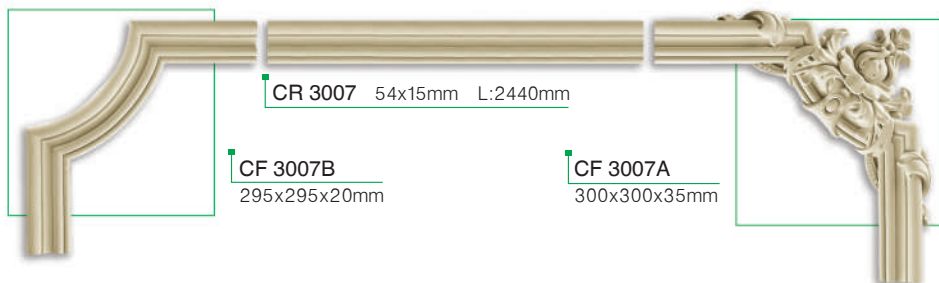
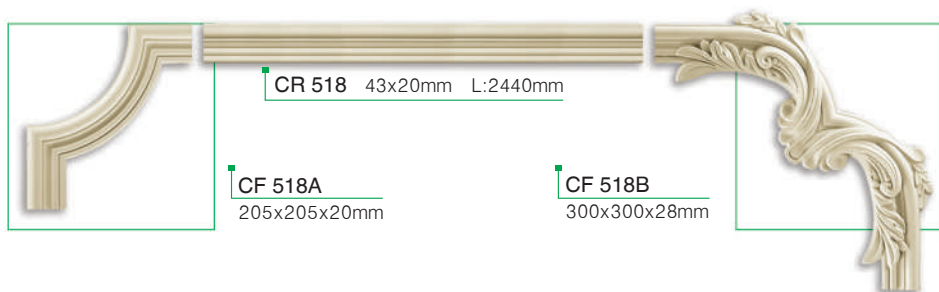

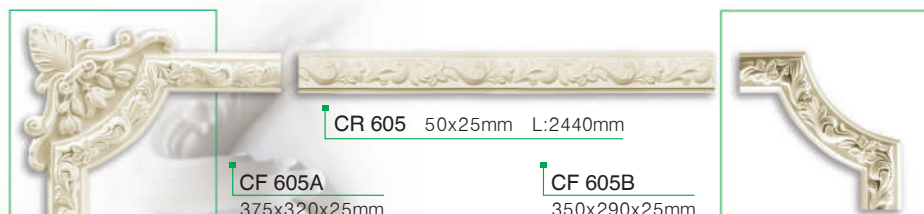
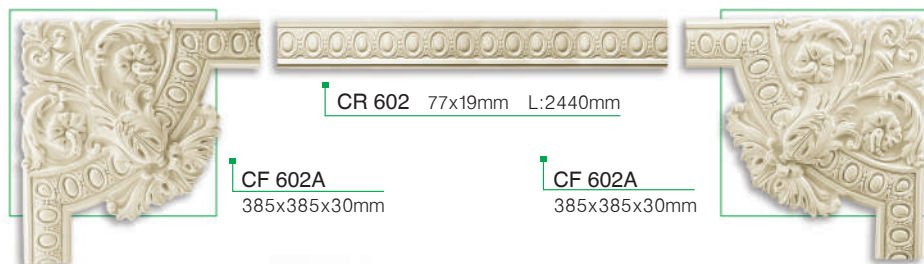
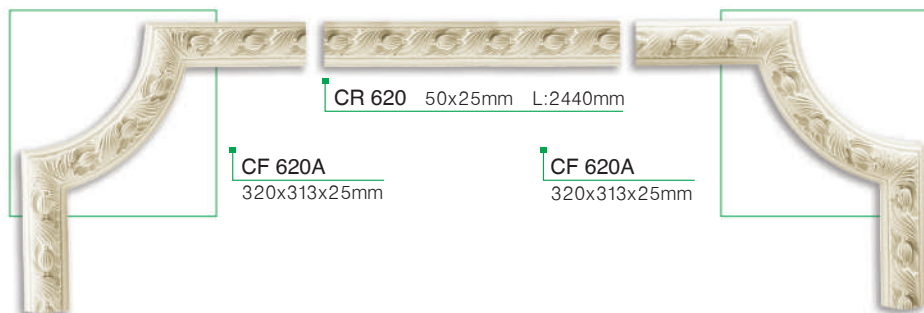

Круговые бордюры - изогнутые молдинги, которые используются для обрамления арочных проемов, нишевых пространств, оформления потолков, создания круговых рамок. С некоторыми из бордюров стыкуются молдинги.

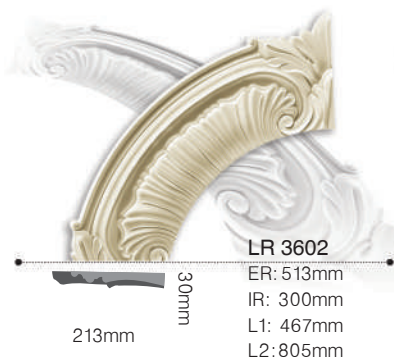
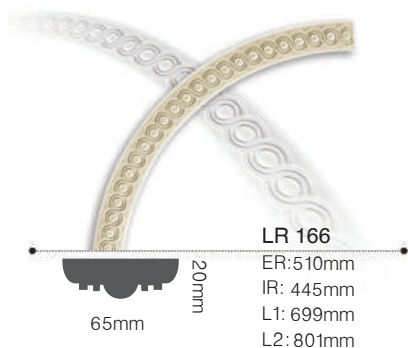
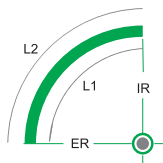
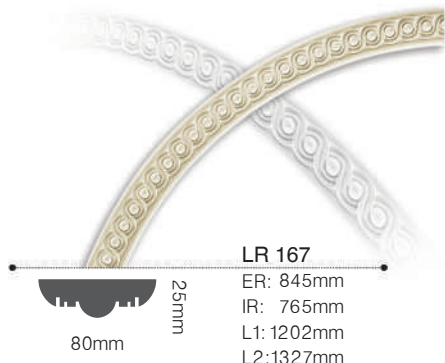

Круговые бордюры



LR 3073/50	LR 3073/65
ER: 547mm	ER: 697mm
IR: 500mm	IR: 650mm
L1: 785mm	L1: 1021mm
L2: 859mm	L2: 1095mm



LR 3073F(R)/50

LR 3073F(R)/65

105x50x27mm

LR 3073F(L)/50

LR 3073F(L)/65

105x50x27mm



LR 3073R/50

LR 3073R/65

105x50x27mm



CR 3073 Size: 49mm L: 2440mm



LR 689/60	LR 689/70
ER: 662mm	ER: 762mm
IR: 600mm	IR: 700mm
L1: 942mm	L1: 1099mm
L2: 1039mm	L2: 1197mm



LR 689F(R)/60

LR 689F(R)/70

105x50x27mm

LR 689F(L)/60

LR 689F(L)/70

105x50x27mm



LR 689R/60

LR 689R/70

105x50x27mm



CR 689 Size: 62mm L: 2440mm

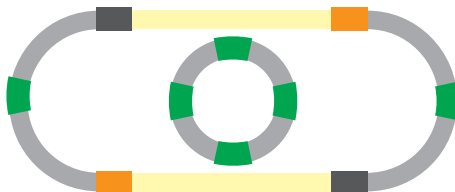

LR 3073 ● **LR 689**

LR 3073/50 LR 3073/65 ● LR 689/60 LR 689/70

LR 3073R/50 LR 3073R/65 ● LR 689R/60 LR 689R/70

LR 3073F(L)/50 LR 3073F(L)/65 ● LR 689F(L)/60 LR 689F(L)/70

LR 3073F(R)/50 LR 3073F(R)/65 ● LR 689F(R)/60 LR 689F(R)/70

Традиционно потолочные розетки составляют центральную часть композиции потолка и оформляют пространство вокруг люстры.

Сегодня некоторые дизайнеры используют их в качестве орнамента на потолке или стене. Вместе с подобранными молдингами и карнизами придают потолку законченный вид.



R 4015
 Ø 200mm
 H: 40mm



R 316
 Ø 300mm
 H: 35mm



R 4016
 Ø 300mm
 H: 32mm



R 371
 305x435mm
 H: 38mm



R 314
 315x600mm
 H: 45mm



R 318
 Ø 335mm
 H: 45mm



R 312
 Ø 400mm
 H: 32mm



R 4017
 Ø 400mm
 H: 36mm



R 4030
 Ø 400mm
 H: 45mm



R 4032
⌀ 400mm
H: 42mm



R 4033
⌀ 400mm
H: 49mm



R 350
⌀ 410mm
H: 24mm



R 303
⌀ 415mm
H: 45mm



R 4025
⌀ 430mm
H: 22mm



R 311
⌀ 435mm
H: 44mm



R 4037
⌀ 450mm
⌀ 100mm
H: 41mm



R 304
⌀ 460mm
H: 25mm



R 347
⌀ 460mm
H: 45mm



R 349

⌀ 460mm
H: 36mm



R 4012

⌀ 475mm
H: 48mm



R 4038

⌀ 478mm
⌀ 100mm
H: 50mm



R 313

⌀ 482mm
H: 35mm



R 309

⌀ 495mm
H: 58mm



R 4022

⌀ 500mm
H: 55mm



R 4019

500x800mm
H: 31mm



R 310

⌀ 515mm
H: 32mm



R 4029
Ø 520mm
H: 35mm



R 345
Ø 525mm
H: 29mm



R 4031
Ø 540mm
H: 50mm



R 317
Ø 560mm
H: 55mm



R 348
Ø 575mm
H: 27mm



R 4039
Ø 596mm
Ø 100mm
H: 48mm



R 306
Ø 600mm
H: 46mm



R 4023
Ø 600mm
H: 31mm



R 301
Ø 605mm
H: 71mm



R 305
Ø 660mm
H: 65mm



R 4006
Ø 665mm
H: 65mm



R 336
Ø 667mm
H: 20mm



R 337
Ø 670mm
H: 55mm



R 338
Ø 687mm
H: 51mm



R 4024
Ø 720mm
H: 61mm



R 361
730x1080mm
H: 25mm





R 335
Ø 738mm
H: 49mm



R 308
Ø 760mm
H: 45mm



R 120
Ø 770mm
H: 41mm



R 307
Ø 830mm
H: 52mm



R 302
Ø 968mm
H: 79mm



R 4007
Ø 1010mm
H: 65mm

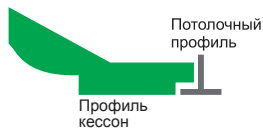

Кессоны - это квадратные или многоугольные углубления на потолке или внутренней поверхности арки, свода или потолка. Кессоны играют конструктивную роль, а также применяются для улучшения акустики помещений. Кессоны монтируются в подвесной гипсокартонный потолок и традиционно используются группой.



R 4009
604×604×40mm



R 4010
603×603×40mm



R 4013
603×603×48mm



R 4014
601×601×75mm



R 4041
609×609×73mm



R 4042
609×609×73mm



R 4043
609×609×84mm



R 4044
609×609×73mm



R 4045
607×607×76mm



R 4046
612×612×78mm



R 4047
609×609×73mm



R 4048
614×614×79mm



R 4049
609×609×76mm



R 4050
603×603×40mm

Многие дизайнеры используют эти украшения на основе сочетания, комбинации, для создания более богатых, наполненных жизнью эффектов и эстетики.

Ощутите удивительную разницу, используя немного воображения.



A 620
Ø 60×10mm



A 373
Ø 63×10mm



A 621
65×65×8mm



A 320
Ø 80×13mm



A 328
89×89×12mm



A 118
95×80×40mm



A 319
Ø 95×15mm



A 324
100×100×20mm



A 989
130×125×20mm



A 322
Ø 155×30mm



A 372
Ø 160×16mm



A 321
Ø 165×25mm



A 323
Ø 210×25mm



A 370
Ø 225×38mm



AW 6020L AW 6020R
125×40×9mm 125×40×9mm



AW 6039L AW 6039R
124×95×13mm 124×95×13mm



AW 6027L AW 6027R
125×80×13mm 125×80×13mm



AW 6074L AW 6074R
295×135×16mm 295×135×16mm



AW 6111L AW 6111R
260×126×15mm 260×126×15mm



AW 6018L AW 6018R
170×50×14mm 170×50×14mm



AW 6051
225×570×30mm



AW 6077
80×52×15mm



AW 6012
73×296×14mm



AW 6071
67×215×15mm



AW 6063
120×615×15mm

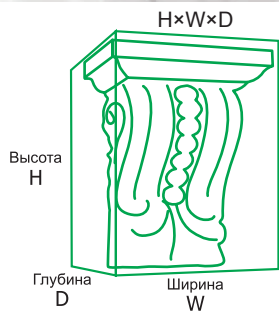

Консоли обычно используют для увеличения привлекательности колонн и потолочных участков. С их помощью завершают дизайнерское оформление на основе иллюзии дерева, гранита. Возможно также использование консолей в качестве полок и опор.



B 824
109×88×43mm



B 972
128×73×35mm



B 821
140×115×70mm



B 823
141×101×65mm



B 822
143×107×67mm



B 827M
152×100×54mm



B 837
168×109×60mm



B 964
168×114×70mm



B 978
185×77×151mm



B 960
189×116×85mm



B 966
191×185×98mm



B 965
206×91×76mm



B 957
212×120×47mm



B 835
220×130×94mm



B 813
223×182×84mm



B 976
238×88×58mm



B 962
250×168×122mm



B 959
253×127×51mm



B 816
265×172×83mm



B 815
269×156×55mm



B 859
715×145×215mm



B 961
281×246×199mm



B 814
282×159×67mm



B 971
301×171×145mm



B 977
310×130×75mm



B 963
314×143×145mm



B 979
325×114×108mm



B 857
382×209×132mm

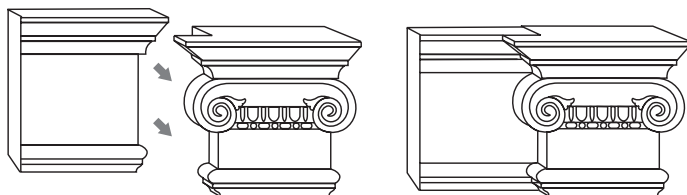
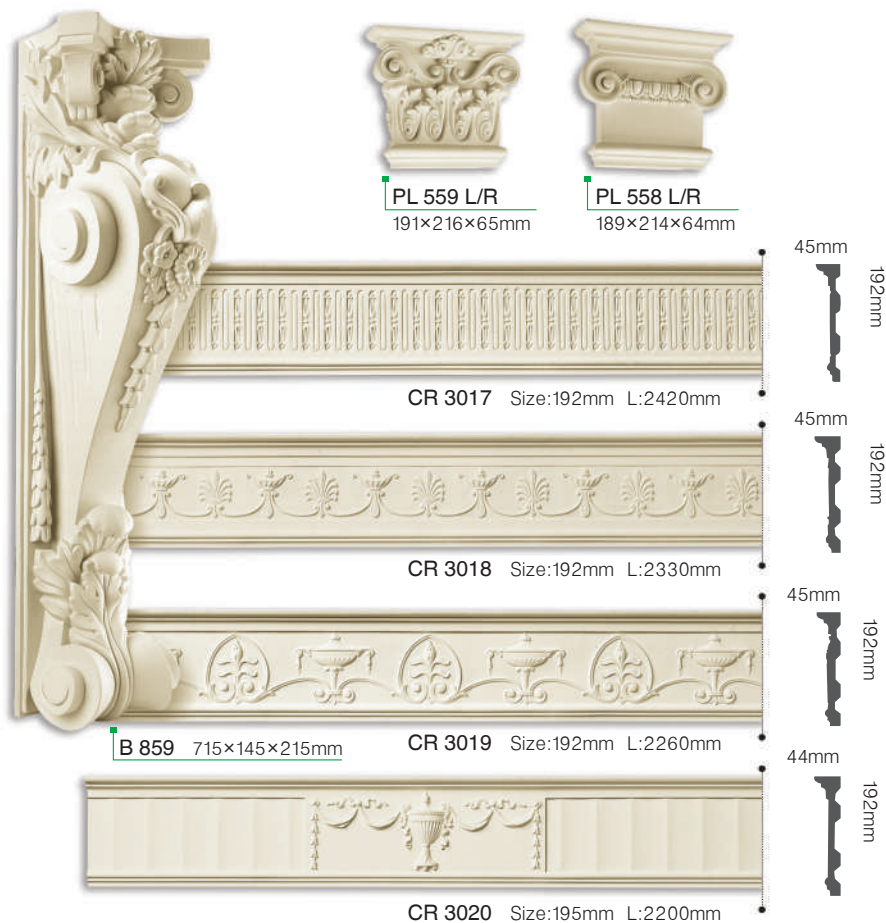



PL 559L + CR 3017 + PL 559R



PL 559L + CR 3018 + PL 559R



PL 558L + CR 3019 + PL 558R



PL 558L + CR 3020 + PL 558R

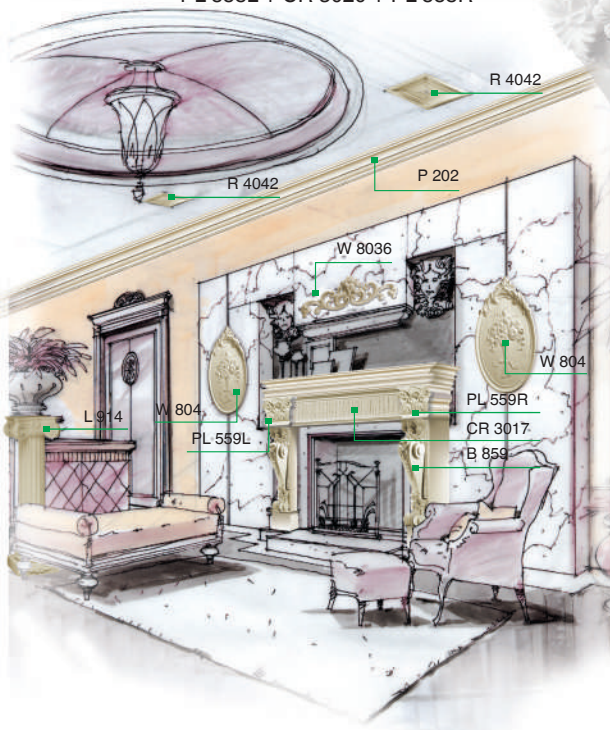

Капитель		PL 558 L/R				
		PL 559 L/R			PL 564	
		PL 554	PL 561	PL 564	PL 565	
	PL 551	PL 562	PL 563	PL 565	PL 567	PL 557
Тело	PL 550	PL 553	PL 573	PL 575	PL 576	PL 553×2
База	PL 552	PL 555	PL 574	PL 566	PL 566	PL 555×2

Пилястры предназначены для вертикального разделения плоскости на функциональные зоны. Могут использоваться парами в обрамлении дверей. При помощи пилястр можно избавиться от скучного, однообразного вида стены.

PL 557

345×419×95mm

PL 551

163×178×45mm

PL 554

145×225×50mm

PL 562

80×242×70mm

PL 550

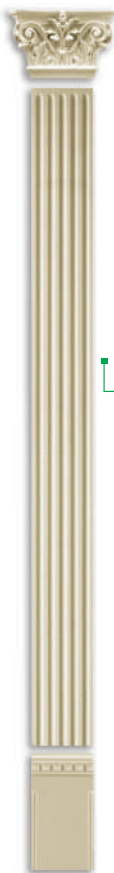
 110×20mm
2000mm

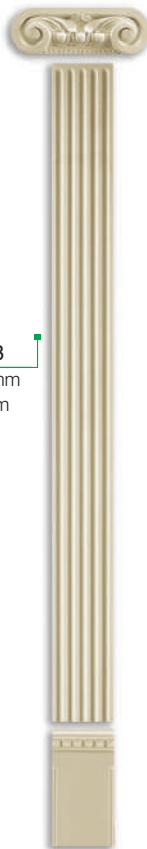
PL 553

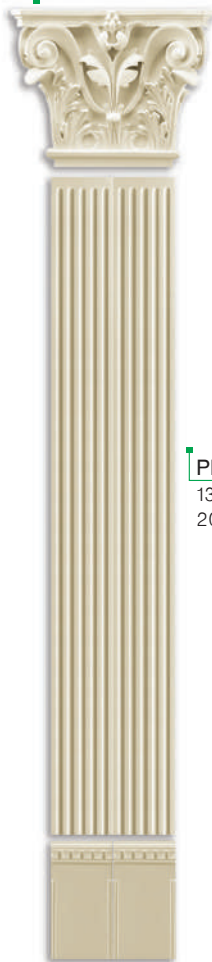
 135×20mm
2000mm

PL 553×2

 135×2×20mm
2000mm

PL 552

 255×110×30mm
E: 2418mm

PL 555

255×135×30mm

E: 2400mm

PL 555×2

 255×135×2×30mm
E: 2600mm

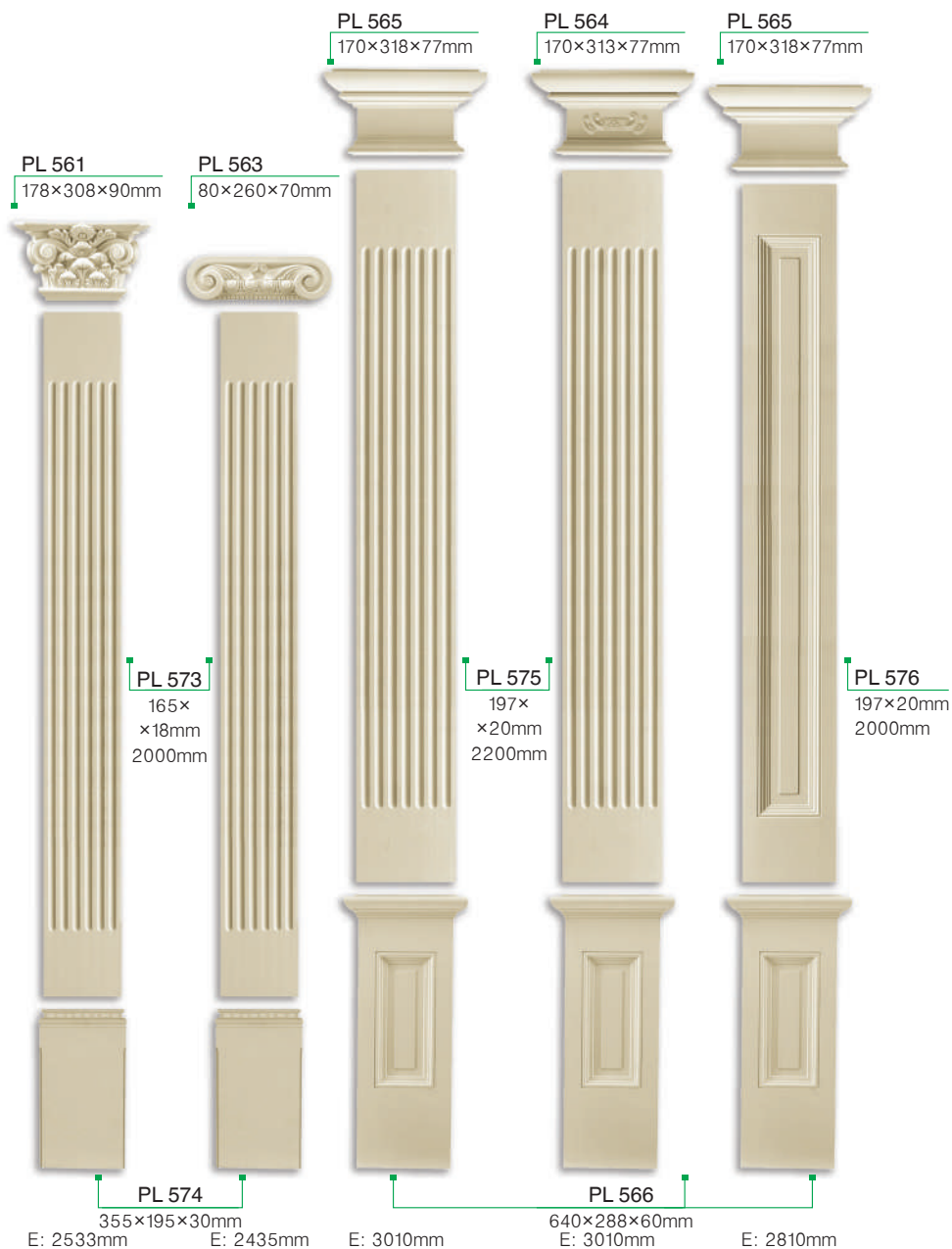

E - общая высота в сборе

PL 564

170×313×77mm



PL 567

212×212×30mm



PL 558 L/R

189×214×64mm



PL 559 L/R

191×216×65mm



PL 576

2000×197×20mm

PL 553

2000×135×20mm

PL 566

640×288×60mm

PL 555

255×135×30mm

E: 2810mm

E: 2852mm

E: 2444mm

E: 2446mm



CR 3017 Size:192mm L:2420mm



CR 3018 Size:192mm L:2330mm



CR 3019 Size:192mm L:2260mm



CR 3020 Size:195mm L:2200mm

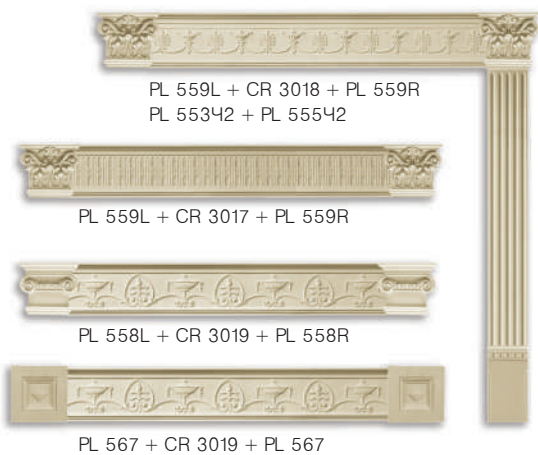

PL 559L + CR 3018 + PL 559R
PL 55342 + PL 55542

PL 559L + CR 3017 + PL 559R

PL 558L + CR 3019 + PL 558R

PL 567 + CR 3019 + PL 567



PL 559 L/R
191×216×65mm



PL 558 L/R
189×214×64mm



PL 567
212×212×30mm



PL 555
255×135×30mm

Колонны используются как опорный элемент карниза, для оформления входа в здание или помещение. Могут быть применены в арочных конструкциях или проемах. Внутри помещения отделяют проходную часть от гостиной. Колонна состоит из капители, тела колонны и базы. Длину тела колонны можно варьировать в зависимости от высоты помещения путем укорачивания или дотачивания необходимой части.

Тело

Капитель

Диаметр	Ширина	Высота	●	◐
∅ 120mm	230mm	85mm	L 9311 F	L 9321 H
∅ 150mm	265mm	105mm	L 9313 F	L 9323 H
∅ 180mm	300mm	115mm	L 9315 F	L 9325 H
∅ 200mm	360mm	125mm	L 9317 F	L 9327 H

Капитель



Диаметр	Ширина	Высота	●	◐
∅ 120mm	228mm	155mm	L 9312 F	L 9322 H
∅ 150mm	290mm	207mm	L 9314 F	L 9324 H
∅ 180mm	330mm	245mm	L 9316 F	L 9326 H
∅ 200mm	375mm	257mm	L 9318 F	L 9328 H

База

Диаметр	Ширина	Высота	●	◐
∅ 120mm	200mm	100mm	L 9309 F	L 9309 H
∅ 150mm	240mm	130mm	L 9310 F	L 9310 H
∅ 180mm	280mm	145mm	L 9319 F	L 9319 H
∅ 200mm	310mm	160mm	L 9320 F	L 9320 H

Диаметр	● Рифленая	◐ Гладкая
∅ 120mm	L 9301	L 9302
∅ 150mm	L 9303	L 9304
∅ 180mm	L 9305	L 9306
∅ 200mm	L 9307	L 9308
Высота	2395mm	2425mm

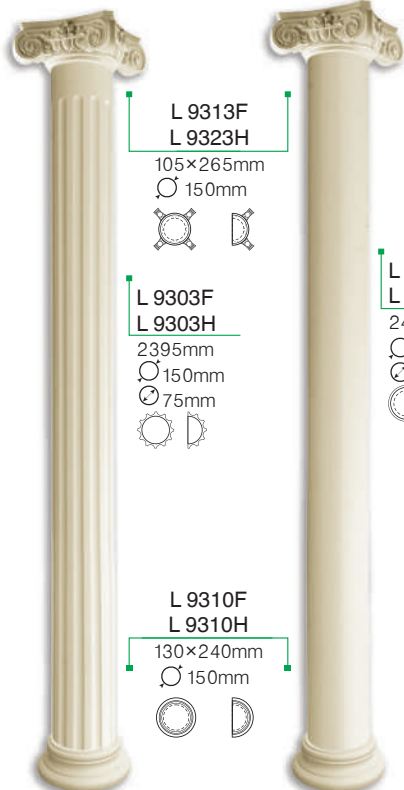



L 9313F
L 9323H
105×265mm
∅ 150mm



L 9303F
L 9303H
2395mm
∅ 150mm
∅ 75mm



L 9310F
L 9310H
130×240mm
∅ 150mm



E: 2630mm

E: 2660mm

L 9304F
L 9304H
2425mm
∅ 150mm
∅ 75mm



L 9314F
L 9324H
207×290mm
∅ 150mm



L 9303F
L 9303H
2395mm
∅ 150mm
∅ 75mm



L 9304F
L 9304H
2425mm
∅ 150mm
∅ 75mm



L 9310F
L 9310H
130×240mm
∅ 150mm



E: 2732mm

E: 2762mm

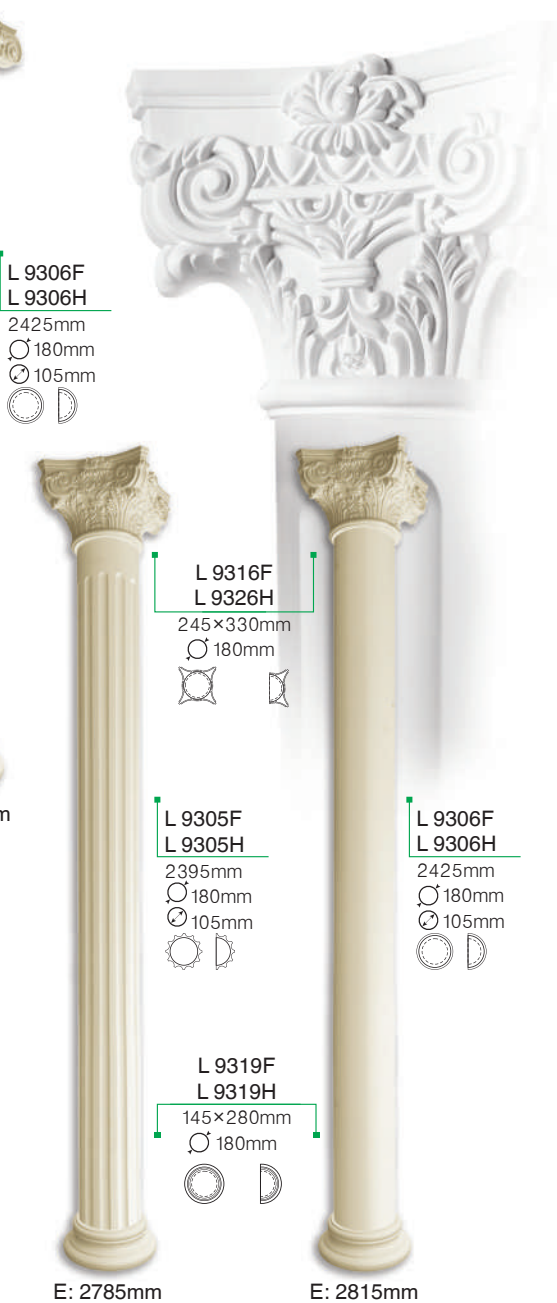
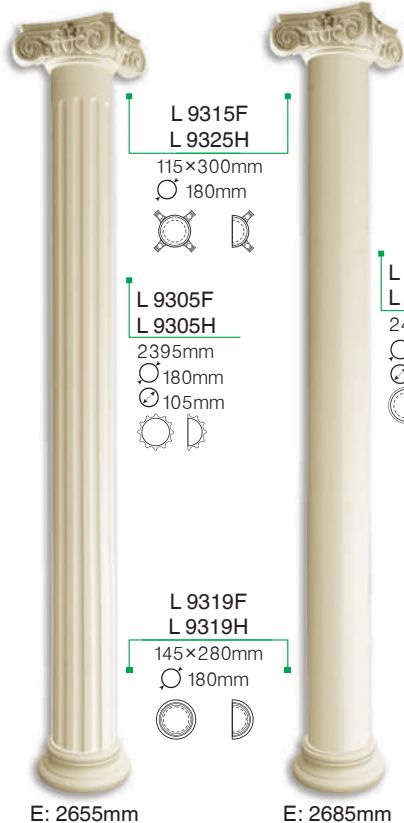

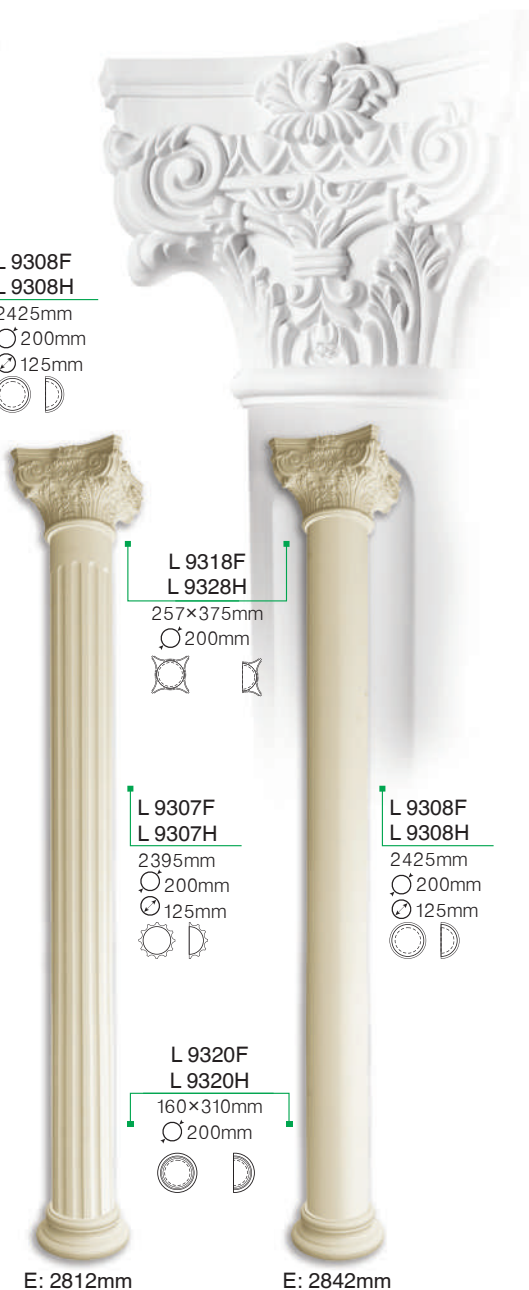
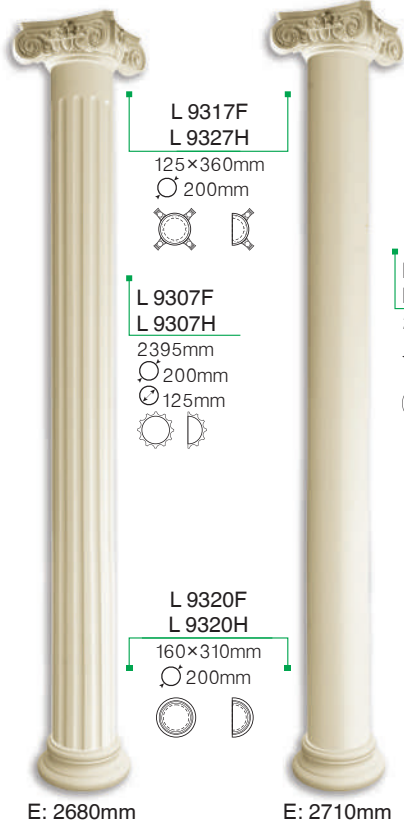

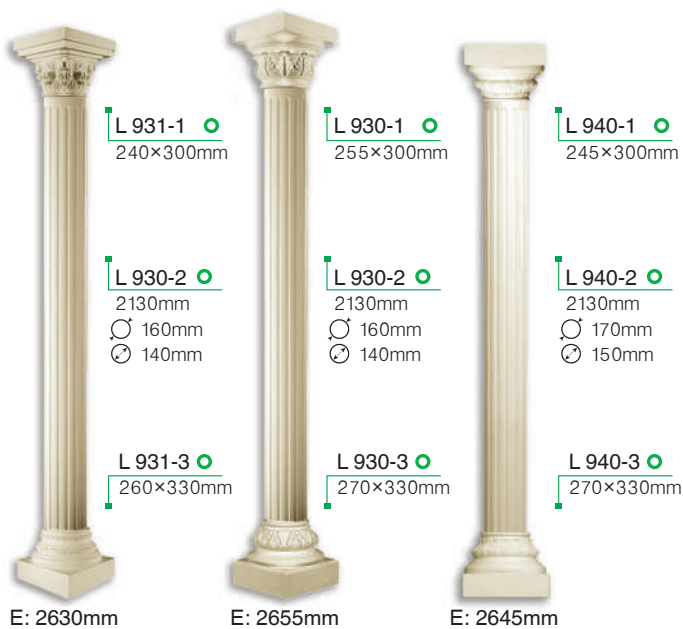
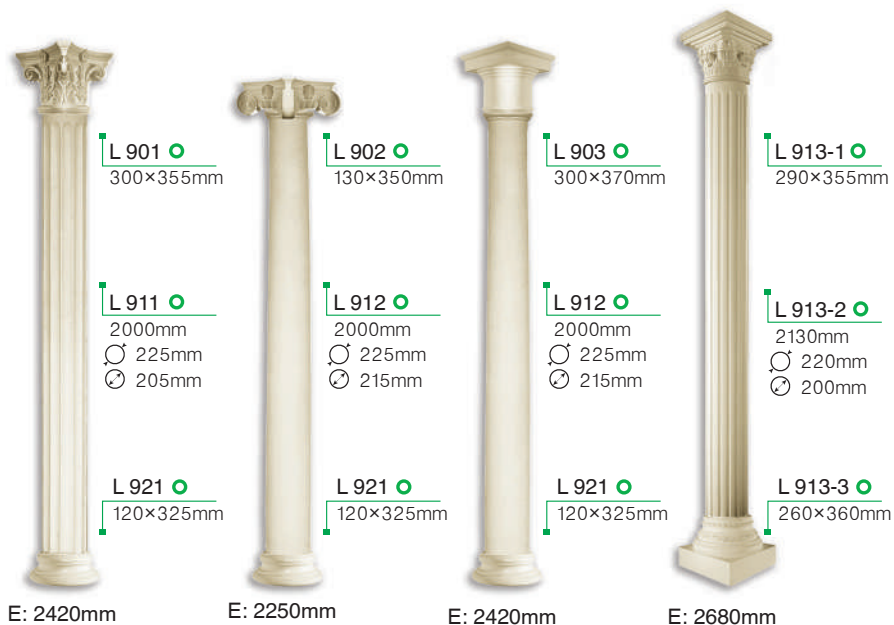

Укороченная колонна может быть использована как пьедестал для статуй, ваз и других декоративных деталей интерьера.

L 905

Высота: 705mm
Капитель: 260mm
Диаметр тела: 220mm
Основание: 300mm

L 925

Высота: 760mm
Капитель: 347mm
Диаметр тела: 320mm
Основание: 347mm

L 920

Высота: 762mm
Капитель: 300mm
Диаметр тела: 160mm
Основание: 300mm

L 919

Высота: 762mm
Капитель: 303mm
Диаметр тела: 160mm
Основание: 300mm

L 926

Высота: 762mm
Капитель: 355mm
Диаметр тела: 220mm
Основание: 360mm

L 924

Высота: 790mm
Капитель: 350mm
Диаметр тела: 220mm
Основание: 300mm

L 915

Высота: 908mm
Капитель: 250mm
Диаметр тела: 120mm
Основание: 250mm

L 904

Высота: 1050mm
Капитель: 310mm
Диаметр тела: 220mm
Основание: 322mm

L 914

Высота: 1170mm
Капитель: 330mm
Диаметр тела: 200mm
Основание: 310mm

Эта коллекция избавит вас от однообразной обстановки. У вас есть выбор средств для создания, желаемой атмосферы. Обычно эти элементы применяются на участках с фонтанами, источниками.

Имитация декоративного оформления из камня.



W 8011A

280×240×37mm



W 8011B

285×240×35mm



W 8011C

285×257×35mm



W 8011D

285×245×35mm



D 597

550×550×16mm



W 8010A

280×240×35mm



W 8010B

285×240×35mm



W 8010C

277×238×37mm



W 8010D

277×238×37mm



D 598

220×550×16mm



W 801

575×685×30mm

W 8044

Ø195



W 8049

369×1195×50mm



W 8048

307×994×21mm



M 901

780×1000×39mm



W 705
80×300×12mm



W 690
390×535×30mm



W 8037
190×165×35mm

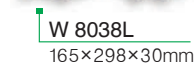

W 8038L
165×298×30mm

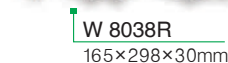

W 8038R
165×298×30mm



W 8028
130×330×30mm



W 8039
180×165×35mm

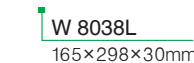

W 8038L
165×298×30mm

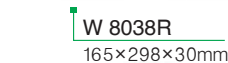

W 8038R
165×298×30mm



W 8025
125×550×37mm

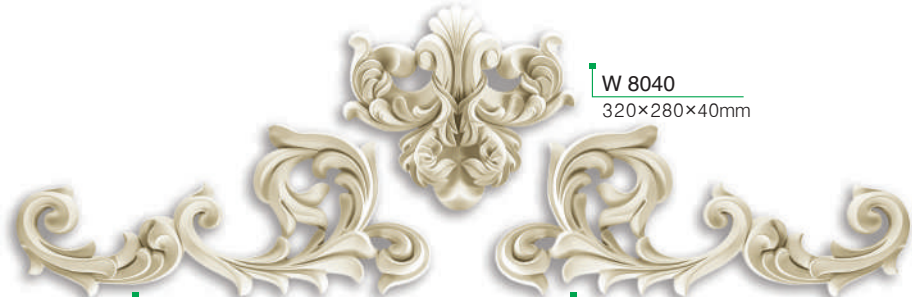

W 8040
320×280×40mm

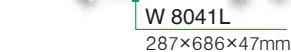

W 8041L
287×686×47mm

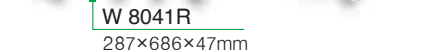

W 8041R
287×686×47mm



W 8021
155×290×25mm



W 703
220×410×35mm



W 988
130×126×18mm



W 8035
190×609×55mm



W 8019
230×387×35mm



W 984
160×117×30mm



W 8027
175×353×52mm



W 8033
170×100×25mm



W 986
125×210×40mm



W 8026S
140×230×30mm



W 8005
81×62×10mm



W 985

176×155×26mm



W 983

180×200×14mm



W 708

185×240×25mm



W 8029

225×416×52mm



W 8029S

160×270×35mm



W 707L

190×415×30mm



W 707R

190×415×30mm



W 8034

225×828×42mm



W 8022
360×795×50mm



W 8036
320×910×50mm



W 706
270×425×20mm



W 762
240×480×16mm



W 8023L
332×80×23mm

W 8023R
332×80×23mm



W 8054
383×365×185mm



W 8055
376×365×185mm



W 805
1400×720×90mm



W 804
738×525×35mm



W 803
790×650×65mm



W 802
810×650×50mm

Обрамление дверных проемов



F D 591
2440×95×21mm

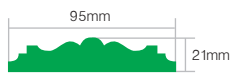

Данные украшения используются как обрамление дверных проемов. Это придает дверям классическое изящество. Лепные украшения предоставляют гибкость в подборе и комбинировании желаемых предпочтений. Они также используются для подчеркивания рельефа двери.



D 593
95×95×25mm



D 588
95×95×50mm



D 600
110×110×28mm

F - элемент имеет гибкий аналог

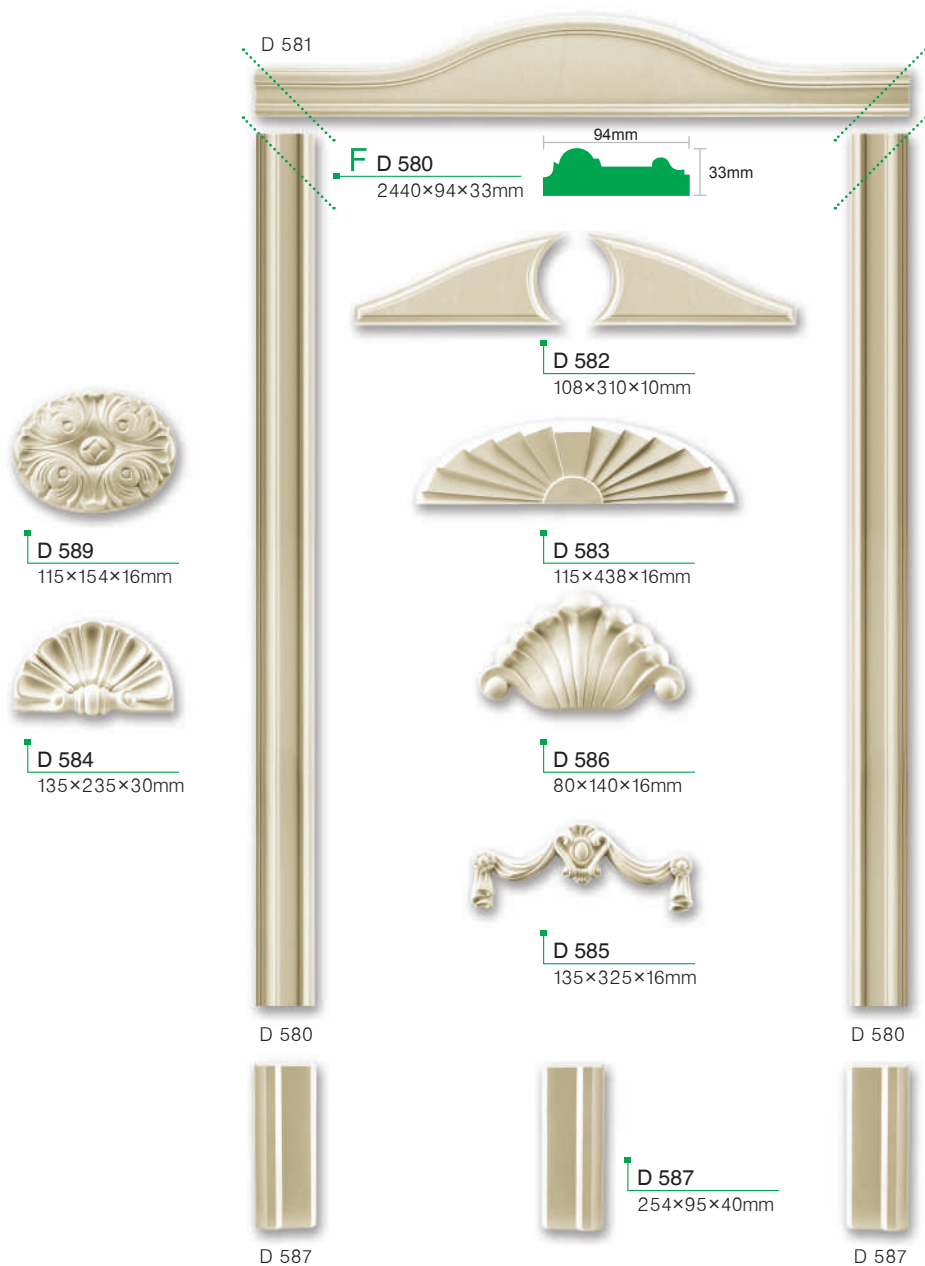

Обрамление дверных проемов



D 581 195×1250×35mm



D 581 + D 586



D 581 + D 583



D 581 + D 584 + D 600×2



D 581 + D 588×2



D 597
550×550×16mm



D 598
220×550×16mm



D 600
110×110×28mm



D 588
95×95×50mm



D 590
95×95×40mm

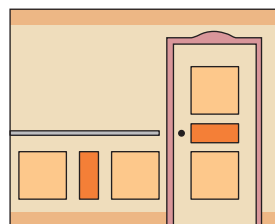
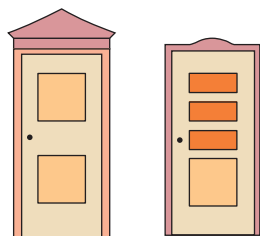

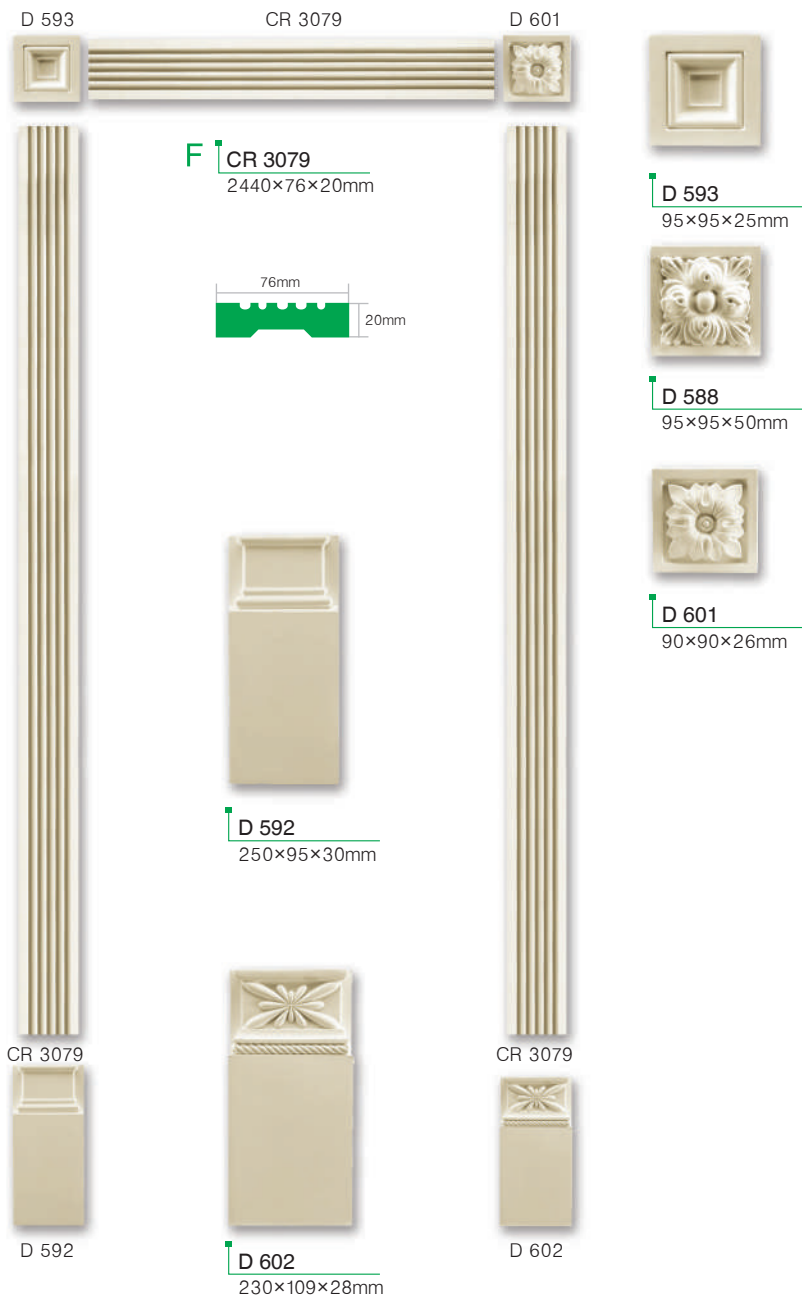

Ниши используются как встроенный элемент декора наружной и внутренней части дома. Пространство внутри ниши может быть заполнено бюстами, статуэтками, цветочными композициями, а также подсвечено.



N 732

A: 280mm
B: 260mm
C: 180mm
D: 380mm
E: 500mm
F: 85mm
G: 85mm
H: 50mm
I: 68mm



N 734

A: 640mm
B: 570mm
C: 450mm
D: 1015mm
E: 1320mm
F: 205mm
G: 335mm
H: 170mm
I: 330mm



N 731

A: 450mm
B: 440mm
C: 360mm
D: 645mm
E: 765mm
F: 85mm
G: 200mm
H: 125mm
I: 190mm



N 736

- A: 690mm
- B: 660mm
- C: 520mm
- D: 970mm
- E: 1145mm
- F: 120mm
- G: 280mm
- H: 210mm
- I: 275mm

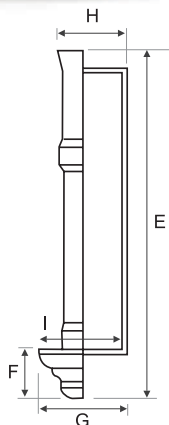
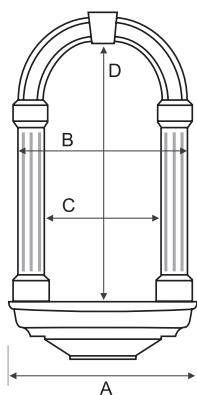

N 738

- A: 555mm
- B: 515mm
- C: 375mm
- D: 740mm
- E: 1000mm
- F: 190mm
- G: 242mm
- H: 145mm
- I: 223mm



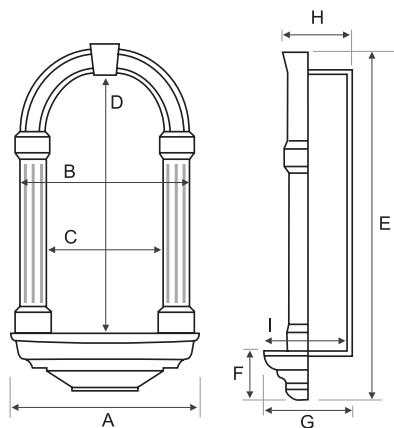

N 733-A

- A: 420mm
- B: 375mm
- C: 265mm
- D: 560mm
- E: 765mm
- F: 135mm
- G: 200mm
- H: 125mm
- I: 190mm

N 733

- A: 420mm
- B: 375mm
- C: 265mm
- D: 560mm
- E: 765mm
- F: 135mm
- G: 105mm
- H: 30mm

Потолочные купола разработаны для преобразования потолка, придавая приятную иллюзию глубины и объема. Изготовлены из уплотненного полиуретана и пластика.

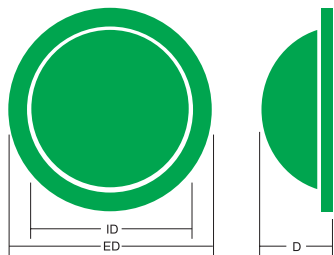

○ **DM 3501**
 ED: 1230mm
 ID: 980mm
 D: 230mm



○ **DM 3502**
 ED: 1230mm
 ID: 1080mm
 D: 200mm



○ **DM 3503**
 ED: 720mm
 ID: 570mm
 D: 125mm



DM 3504
ED: 1130mm
ID: 995mm
D: 215mm



DM 3505
ED: 1448mm
ID: 1220mm
D: 272mm



DM 3506
ED: 1225mm
ID: 1065mm
D: 215mm



○ **DM 3507**
ED: 1168mm
ID: 1005mm
D: 238mm



○ **DM 3508**
ED: 1130mm
ID: 930mm
D: 250mm



○ **DM 3509**
ED: 1530mm
ID: 1430mm
D: 90mm



DM 3510
ED: 950mm
ID: 820mm
D: 50mm



DM 3512
ED: 2020mm
ID: 1760mm
D: 190mm



DM 3513
ED: 2020mm
ID: 1760mm
D: 420mm

Оглавление

Карнизы с гладким профилем

P 132	8	C 129	F	10
P 133	8	C 138		13
P 134	F 5	C 140	F	14
P 135	F 7	C 141	F	11
P 136	F 6	C 143		14
P 149	9	C 144		11
P 201	F 6	C 147	F	10
P 202	F 7	C 150		15
P 203	F 7	C 152		11
P 205	F 5	C 156		15
P 207	F 6	C 158	F	14
P 208	F 5	C 159	F	15
P 210	F 5	C 160	F	12
P 212	F 5	C 161	F	10
P 214	F 5	C 173	F	11
P 219	F 5	C 176	F	11
P 220	F 5	C 177	F	13
P 221	F 4	C 204		15
P 222	F 4	C 233		14
P 223	F 7	C 1001	F	11
P 224	F 4	C 1002	F	12
P 232	F 6	C 1003	F	10
P 880	9	C 1004	F	13
P 881	5	C 1005	F	10
P 882	6	C 1006		14
P 883	5	C 1007	F	12
P 884	7	C 1008	F	10
P 885	7	C 1009	F	12
P 886	4	C 1010	F	12
P 887	6	C 1012	F	15
P 888	9	C 1013	F	12
P 2001	F 6	C 1014	F	11
P 2002	4	C 1015	F	13
P 2003	4	C 1016	F	10
P 2004	8	C 1018		14
P 2005	7	C 1021		14
P 2006	8	C 1022		15
P 2007	F 5	C 1030		12
P 2008	7	C 1033		14
P 2009	F 5	C 1035		13
P 2010	F 4	C 1036		13
P 2011	8	C 1037		14
P 2012	F 4	C 1041	F	10
P 2016	F 7	C 1044	F	11
P 2024	9	C 1049		15
P 2026	9	C 1060	F	15
P 2031	9	C 1061		14
P 2032	8	C 1063	F	14
P 2048	F 7	C 1067	F	13
P 2055	F 7	C 1068	F	13
P 2056	6	C 1071		13
P 2057	4	C 1075		15
P 2072	F 7	C 1079	F	11
P 2076	F 6	C 1084		11
P 2119	F ● 4	C 1085	F	10
		C 1088	F	13
		C 1090	F	10
		C 1091		18
		C 1092		18
		C 1093		18
		C 1097		13
		C 1113	F	11
		C 18100		12

Карнизы с орнаментом

C 101	14
C 102	14
C 104	F 13
C 109	14
C 110	14
C 117	14
C 118	14
C 119	14
C 121	F 14
C 122	14
C 123	F 14
C 124	F 14
C 125	14
C 126	15
C 127	14
C 128	F 11

Молдинги

CR 137	F	24
CR 153	F	23
CR 154	F	22
CR 155	F	23
CR 199	F ●	23
CR 200	F ●	25
CR 402	F	22
CR 403	F	23
CR 404	F	22
CR 405	F	21

CR 407	F	19
CR 512	F	24
CR 516	F	23
CR 518	F	20.28
CR 601	F	21
CR 602	F	22.29
CR 605	F	20.29
CR 607	F	20.29
CR 608	F	25
CR 610	F	20.27
CR 620	F	20.29
CR 622	F	21
CR 624	F	20.27
CR 632	F	25
CR 636	F	23
CR 638	F	23
CR 639	F ●	22
CR 642	F	21
CR 644	F	22
CR 646	F	25
CR 681	F	20
CR 683	F	21
CR 685	F	19
CR 686	F	19
CR 687	F	20
CR 688	F	21
CR 689	F	21
CR 3001	F	24
CR 3002	F	20
CR 3003	F	19
CR 3006	F	21
CR 3007	F	21.28
CR 3008	F	24
CR 3009	F	24
CR 3010	F	19.28
CR 3017	F	26.44.49
CR 3018	F	26.44.49
CR 3019	F	26.44.49
CR 3020	F	26.44.49
CR 3022		21
CR 3023		21
CR 3025	F	20
CR 3034	F	19
CR 3035	F	19
CR 3043	F ●	25
CR 3044	F	24
CR 3051		24
CR 3054	F	19
CR 3057		21
CR 3059		22
CR 3063	F	19.27
CR 3072	F	20
CR 3073	F	20
CR 3075	F	19
CR 3079	F	22.68
CR 3100	F	19
CR 3227	F	19
CR 3241	F ●	25
CR 3242	F ●	24
CR 3243	F ●	23
CR 3245		25
CR 3246		25
CR 3247		26

Угловые элементы

CF 518A	28
CF 518B	28
CF 602A	29
CF 605A	29
CF 605B	29
CF 607B	29
CF 611	27
CF 612	27
CF 613	27
CF 614	27

CF 620A	29
CF 624A	27
CF 624B	27
CF 3007A	28
CF 3007B	28
CF 3010A	28
CF 3010B	28
CF 3010C	28
CF 3010D	28
CF 3010E	28
CF 3063A	27
CF 3063B	27

Круговые бордюры

LR 166	30
LR 167	30
LR 168	30
LR 689/60	31
LR 689/70	31
LR 689F(L)/60	31
LR 689F(L)/70	31
LR 689F(R)/60	31
LR 689F(R)/70	31
LR 689R/60	31
LR 689R/70	31
LR 3073/50	31
LR 3073/65	31
LR 3073F(L)/50	31
LR 3073F(L)/65	31
LR 3073F(R)/50	31
LR 3073F(R)/65	31
LR 3073R/50	31
LR 3073R/65	31
LR 3601	30
LR 3602	30

Потолочные розетки

R 120	37
R 301	35
R 302	37
R 303	33
R 304	33
R 305	36
R 306	35
R 307	37
R 308	37
R 309	34
R 310	34
R 311	33
R 312	32
R 313	34
R 314	32
R 316	32
R 317	35
R 318	32
R 335	37
R 336	36
R 337	36
R 338	36
R 345	35
R 347	33
R 348	35
R 349	34
R 350	33
R 361	36
R 371	32
R 4006	36
R 4007	37
R 4012	34
R 4015	32
R 4016	32
R 4017	32
R 4019	34
R 4022	34

Интернет-магазин декоративно-отделочных материалов



decorshop.ua

044 332 33 77

063 523 60 60

096 050 60 60

066 623 60 60

Киев, бульвар Академика Вернадского 26